



ESPLOSO

P55 - M220

1	32.1005.035	24	32.1005.415	50	32.1015.905
2	84.3755.000	25	32.1005.420	51	32.1015.252
3	26.0005.232	26	26.1005.203	-	32.1015.262
4	32.1005.410	27	32.1005.195	-	32.1015.253
5	86.2494.000	28	26.0050.202	-	32.1015.263
6	81.4599.000	29	32.1025.100	52	26.1010.221
7	86.2120.000	30	32.1005.213	53	82.6016.000
8	81.4588.000	31	26.3005.135	54	26.1005.901
9	26.0050.200	32	23.1005.256	55	84.3812.000
10	86.2685.000	33	32.1005.218	56	26.1005.920
11	22.0005.199	36	26.0050.201	57	81.4645.000
12	23.1005.903	37	86.2741.000	58	85.2520.000
13	32.2005.176	38	84.3708.000	71	86.2120.000
14	26.0005.230	39	32.1005.120		
15	32.1005.408	-	32.1005.121		
16	86.3254.000	40	26.0005.220	78	32.1015.254
17	32.2005.900	41	84.3818.000	83	86.2160.000
18	80.1102.000	42	81.4549.000	85	86.1942.000
19	81.2586.000	43	80.8990.000	87	32.1005.316
20	32.1005.217	46	86.1998.500	88	32.1015.255
21	32.1005.194	48	32.1005.080		
22	32.1005.417	-	32.1005.078		
23	26.1005.102	49	80.2060.000	89	32.1015.256
				90	32.2005.300
				91	81.4530.090
				92	32.2005.930
				93	32.2005.301

○ Destro - Right - Recht - Droite
● Sinistro - Left - Link - Gauche

□ Rosso - Red - Rot - Rouge
■ Verde - Green - Grüne - Vert

◇ Ruota pneumatica - Pneumatic wheel
- Luftreifen - Roue pneumatique
◆ Ruota piena - Solid wheel
Vollreifen - Roue pleine

Dalla produzione del 01/2012 →
From production 01/2012
Ab dem Produktion vom 01/2012
Depuis la production du 01/2012

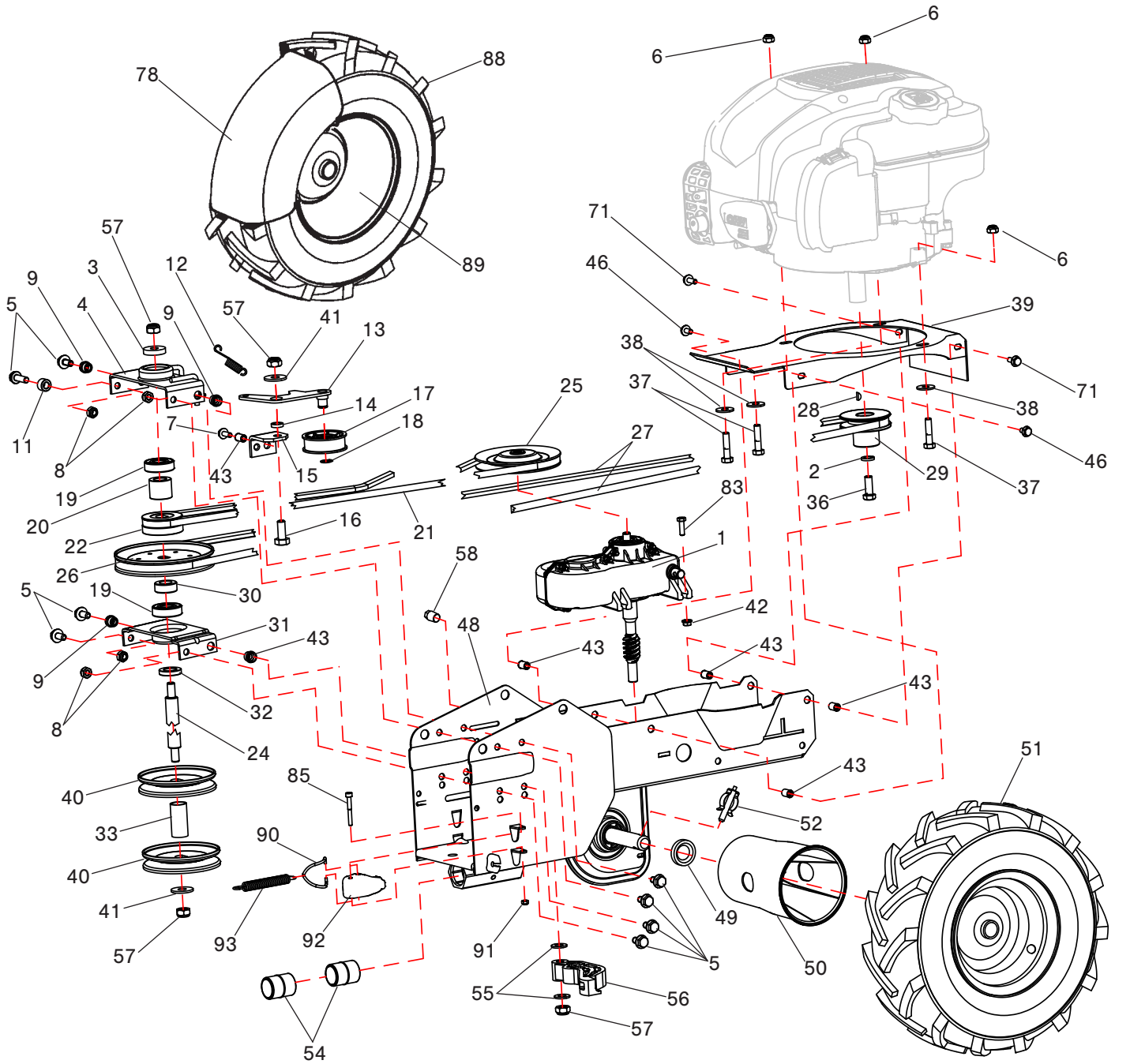

34	32.1005.321	73	32.1005.308
47	81.2572.000 ←	74	32.1005.901 ←
-	81.2523.000	-	32.1005.902
50	32.1005.316	75	80.3056.000
58	85.2520.000	76	32.1005.317
59	32.1005.318	77	32.1005.320
60	32.1005.322	79	80.1105.000
61	81.2632.000	80	32.1005.306
62	80.2122.000	81	81.2577.000
63	32.1005.312	82	32.1005.300 ○ ←
64	80.3051.000	-	32.1005.304 ○ ←
65	81.2694.000	-	32.1005.302 ● ←
66	32.1005.314	-	32.1005.305 ● ←
67	85.1166.000	84	86.1935.000 ←
68	84.7412.000	-	86.1936.000
69	32.1005.315	85	86.1942.000
70	23.0005.906	86	81.4530.080
71	32.1005.313	87	32.1005.316
72	32.1005.345		

○ Destro - Right - Recht - Droite
 ● Sinistro - Left - Link - Gauche

← Fino alla produzione del 12/2012
 Until production 12/2012
 Bis zur Produktion vom 12/2012
 Jusqu'à la production du 12/2012

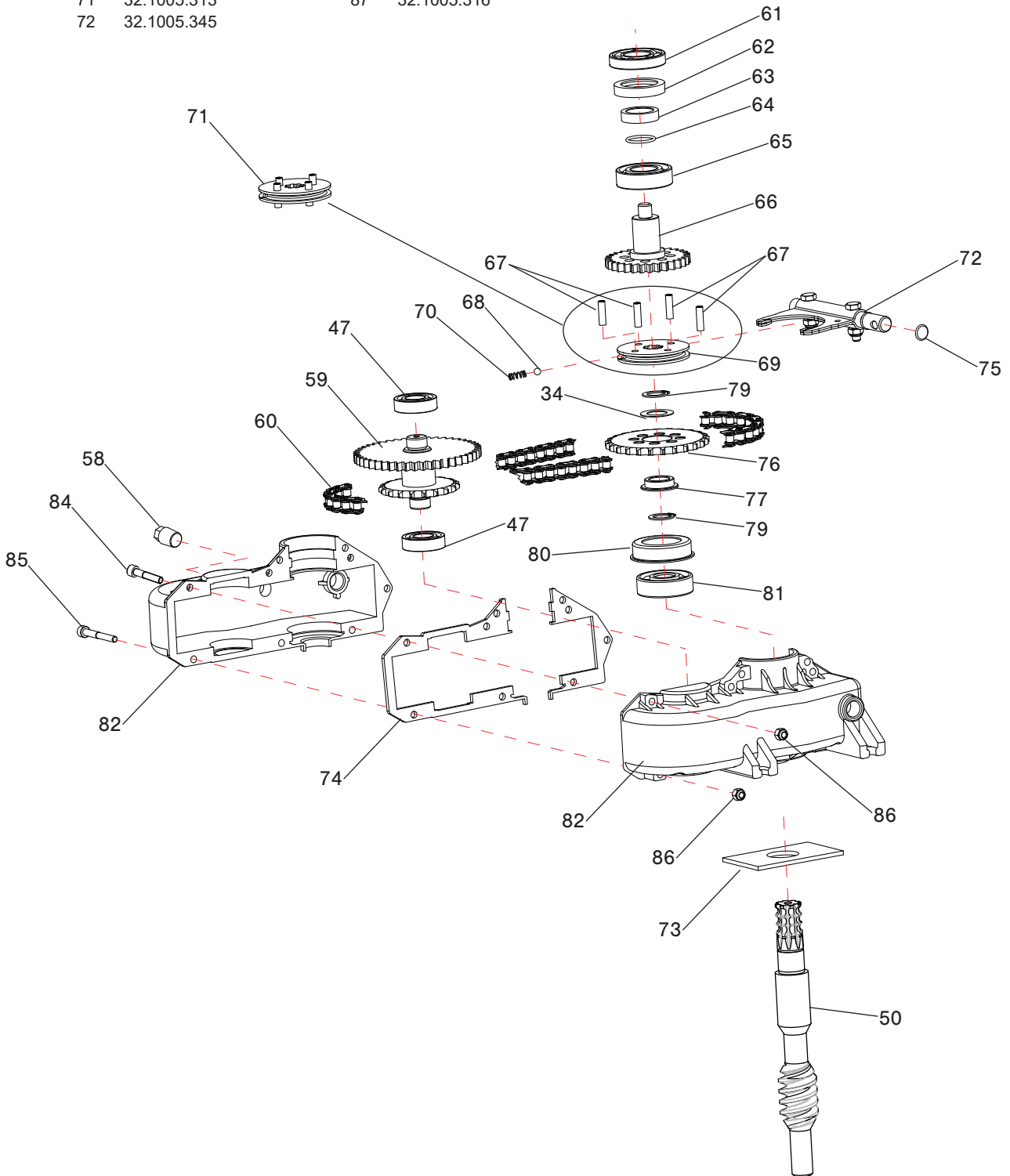

1	81.4588.000	47	32.1010.316	66	32.1010.220
10	32.1010.159	48	23.1010.209	67	32.1010.910
12	86.1840.275	49	32.1010.174	69	85.1350.000
19	81.4548.000	50	26.0050.200	70	85.1236.000
23	84.3685.000	51	86.3047.000	71	32.1010.226
25	84.3605.010	52	22.0010.909	72	32.1005.335
30	86.2685.000	54	83.7528.000	73	85.1262.000
31	86.2494.000	55	32.1010.332	74	32.1010.224
34	86.2356.200	-	23.1020.227	75	26.1010.210
36	32.1010.920	56	32.1010.145	76	32.1010.200
-	32.1010.930	-	32.1010.146	77	26.1010.305
37	84.3711.000	57	23.1010.224	78	26.1010.304
38	86.2881.000	58	22.0050.900		
39	36.0010.130	59	23.1010.223		
41	26.1010.302	60	80.3050.000		
42	82.6016.000	61	80.1039.000		
43	33.0010.910	62	23.1010.219		
45	36.0010.185	64	23.1005.906		
46	32.1010.302	65	32.1005.352		
-	40.0010.096	-	32.1005.353		

○ HONDA
● B&S 675 EXi series

□ Rosso - Red - Rot - Rouge
■ Verde - Green - Grüne - Vert

